

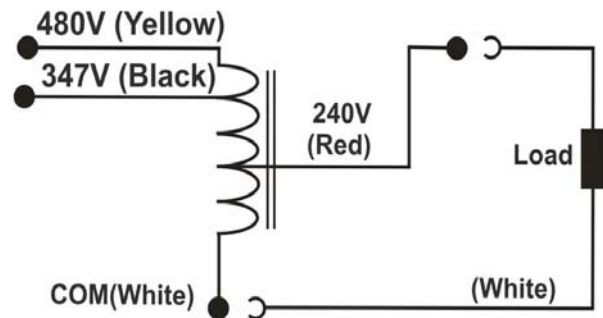

Model No.	MTM00506224C-EC
Product Type	Step-down Transformer
Rating (VA)	50
Vin Vout	480/347VAC 240VAC
Frequency	60 Hz
Status	Production

Input Voltage (V)		480/347
Max Input Circuit (A)		0.12/0.16
Max Output Circuit (A)		0.21
Max. Load(VA)		50
Output Voltage (V)		240
Full Load	EFF. (%)	90/92
	THD (%)	6.2/6.7
	Power Factor	0.976/0.974
UL Class B 130 Temp. Code		A
Case Dimension (inches/mm)	L	3.8/97
	W	1.7/42
	H	1.3/34
	M1	1.3/33
	M2	3.3/84
	A	1.8/45
	B	3.9/100
Max Net Weight (lbs)		1.22
Lead Length (inches)		8±0.5

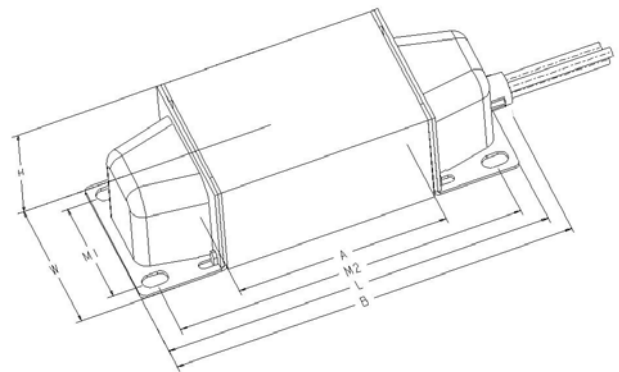

*Lead Type: (AVLV2), Type 3135, No. 18 AWG (or Equivalent), rated 200°C, 600 V. Strip 10mm Tin Plated. [347V lead wire is pre-insulated.](#)

Document No.:	PS_MTM_VA0050_62-24_C_EC_M01
Date:	2018-03-19 (yyyy-mm-dd)

Product Standards: UL 5085-1, UL 5085-2
UL CCN: XPTQ, XPTQ7