

Main Features:

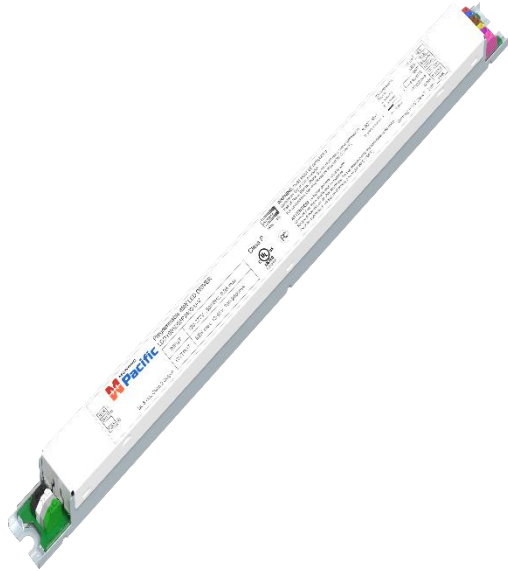

- Input Voltage: 120~277Vac
- Output Wattage: Constant Current (C.C.) at 85W with Adjustable Current Setting
- Flicker-Free : Active PFC 2-Stage Switch Mode
- Programmable Method: Wire
- High Efficiency: Up to **91%**
- Dimming Function: **0-10V with Dim to off (dto)**
- Smooth & Continuous Deep Dimming : **100% to 1%**
- Lightning Protection: Built-in [Line to line 2.5kV, line to ground 2.5kV]
- Reliability Protection: **SCP, OTP, MTP, OCP, OVP**
- Safety Regulation: Complies with UL8750 & EN61347
- Complies with CA Title 24 & FCC Class A
- **Class P** UL standard for retrofit kit
- **Five Year** Warranty under Normal Usage Conditions



SPECIFICATION

Model No. (*)	Output Voltage Range	C.C. or C.P. Programmable Rated Output or Range	Programming Method	Dimming Control Method	Aux
LDD- www(D)vvv(P/F)ccccHH-(V/D)	(Vdc)	(mA) ⁽ⁱ⁾			(Vdc)
LDDY085D55P2400-U-V	10 - 55	700 - 2400	Analog/Wire	0-10V	12
(*) model name pattern: LDD-www(D)vvv(P/F)ccccHH-(V/D) LDD means, LED Driver with C.C. (D) means, 12V Aux (P/F) means, Wire/Wireless Programming method (V/D) means, Analog Voltage/Digital DALI Dimming method	⁽ⁱ⁾ Pre-set Constant Current Value with dimming Case Temp: Tc: 85°C MTP (Module Temperature Protection) :supports thermal feedback and robust thermal manage,LED module working temperature can automatically be reduced by the driver, setting by software of the output current decrease depending on the measured NTC value to avoid decreased lifetime of the LED module. SCP (Short Circuit Protection): No Damage. Auto recovery after short is removed. OCP (Output Over Current) Constant Current Limiting circuit 110% IO. OTP (Over Temperature Protection): The temperature is reduced to 105C and the output is automatically restored. OVP (Output Over Voltage) No Damage. Auto recovery after the abnormal disappearance 110% Vo.				

Input Spec.	Condition Description	Min.	Normal	Max.	Units
-------------	-----------------------	------	--------	------	-------

Input Voltage Range	Universal Input	108	120/277	305	VAC
Input Frequency Range		47	50/60	63	Hz
Input Current	At 120 VAC/277 VAC input, full load output			0.9/0.4	A
Power Factor	At 120 VAC/277 VAC input, 25°C full load		>0.9		
Inrush Current	At 120 VAC input, 25°C cold start / At 277 VAC input, 25°C cold start		50/150		A
Leakage Current	@277Vac 60Hz		750		uA
Surge Protection	Differential and common mode, combination wave			2.5K	V

Output Spec.	Condition Description	Min.	Normal	Max.	Units
Current Accuracy	At 25°C, @120Vac & 277Vac, full load		±5		%
Ripple Current	At 25°C, full load, measured at 20MHz bandwidth. The result differs according to different LED load characteristic.			5	% Ip-p (Io)
Overshoot/Undershoot	% of I out max & LED load, at 25°C, measured at 20MHz bandwidth			5	%
Turn-On Delay	Measured at 120Vac/277Vac input and Full Load			0.5	S
Aux Output Voltage	Aux out current 200mA max		12		Vdc

General Spec.	Condition Description	Min.	Normal	Max.	Units
Efficiency	120Vac 277Vac measured at 25°C, full load	88 89	90 91		%
MTBF	For 12V output model, measured at 120Vac input, 100%Load and Tc=85°C, with a failure probability of less than 10%		≥42500		Hours
Lifetime	at Tc < 86°C Full load and nominal input condition		≥50,000		Hours
Operating/Storage Temperature	85%RH/95%RH	-40/-40		55/85	°C
Dimension (L x W x H)	Length x Width x High	424 x 30.0 x 26.0			mm
		16.69/16.45 x 1.18 x 1.02			inch
Weight	Net weight without package				lb/kg

Safety & EMC Compliance	Category	Condition Description
Safety Regulations	UL8750	Light Emitting Diode (LED) Equipment for Use in Lighting Products, Class 2
	CE	Europe: EN 61347-1, EN61347-2-13
	Dielectric Strength (Hi-POT)	Primary to Secondary: 2000Vac /10mA max / 60 seconds (3 seconds for production)
	Insulation Resistance	10M ohm min. @primary to secondary
EMI Standards	FCC	FCC 47CFR Part 15 Class B@ 120Vac, Class A@277Vac
	Energy Star	Surge Immunity Test: NEMA SSL1 – 2010Non-Roadway,100KHz ring wave, 2.5KV, common and differential mode.
EMS Standards	IEC 61000-4-2	Electrostatic discharge (ESD): 8 kV air discharge, 4 kV contact discharge, criteria A
	IEC 61000-4-4	Electrical fast transient (EFT)/ burst-EFT 2kV/5KHz
	IEC 61000-4-5	Surge immunity test, differential and common mode, 2kV, combination wave
	EN 61000-4-6	Conducted Radio Frequency Disturbances Test-CS
	EN 61547	Electromagnetic Immunity Requirements Applies to Lighting Equipment

■ Dimming Curve

Items	Parameter	Min.	Typ.	Max.	Notes /Conditions
0-10V Dimming	Input Absolute Voltage	-2.0V	10V	15V	GRAY
	Output Source Current	---	180uA	200uA	GRAY
	Output Current Range in 0-10V Dimming	0%	---	100%	CCR output
	Output Current in 0-10V Pin Open	---	Normal	---	It's a constant current output with active PFC.
	Output Current in 0-10V Pin Short Circuit	---	0	---	CCR output
PWM Dimming	Input Absolute Voltage	-2.0V	10V	15V	
	Input Current on PWM pin	---	180uA	200uA	
	PWM Frequency	200Hz	---	2KHz	
	PWM Duty	0 %	---	100%	
	Output Current Range in PWM Dimming	0%	---	100%	CCR output
	Output Current in PWM Pin Open	---	Normal	---	It's a constant current output with active PFC.
	Output Current in PWM Pin Short Circuit	---	0	---	CCR output
0-10V & PWM Dimming	Compatible dimming function: 0-10V and PWM dimming.				

Dimming Wire

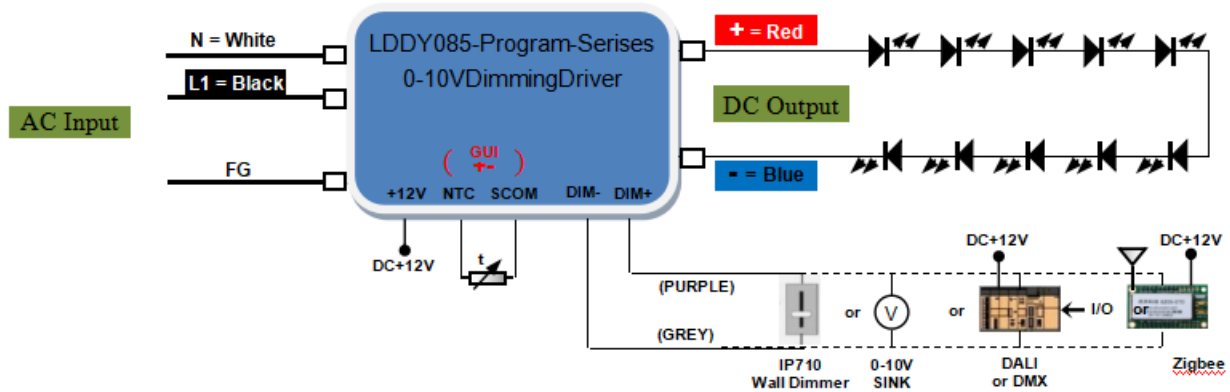

0-10V Dimming Curve@Minimum dimming set to 0:

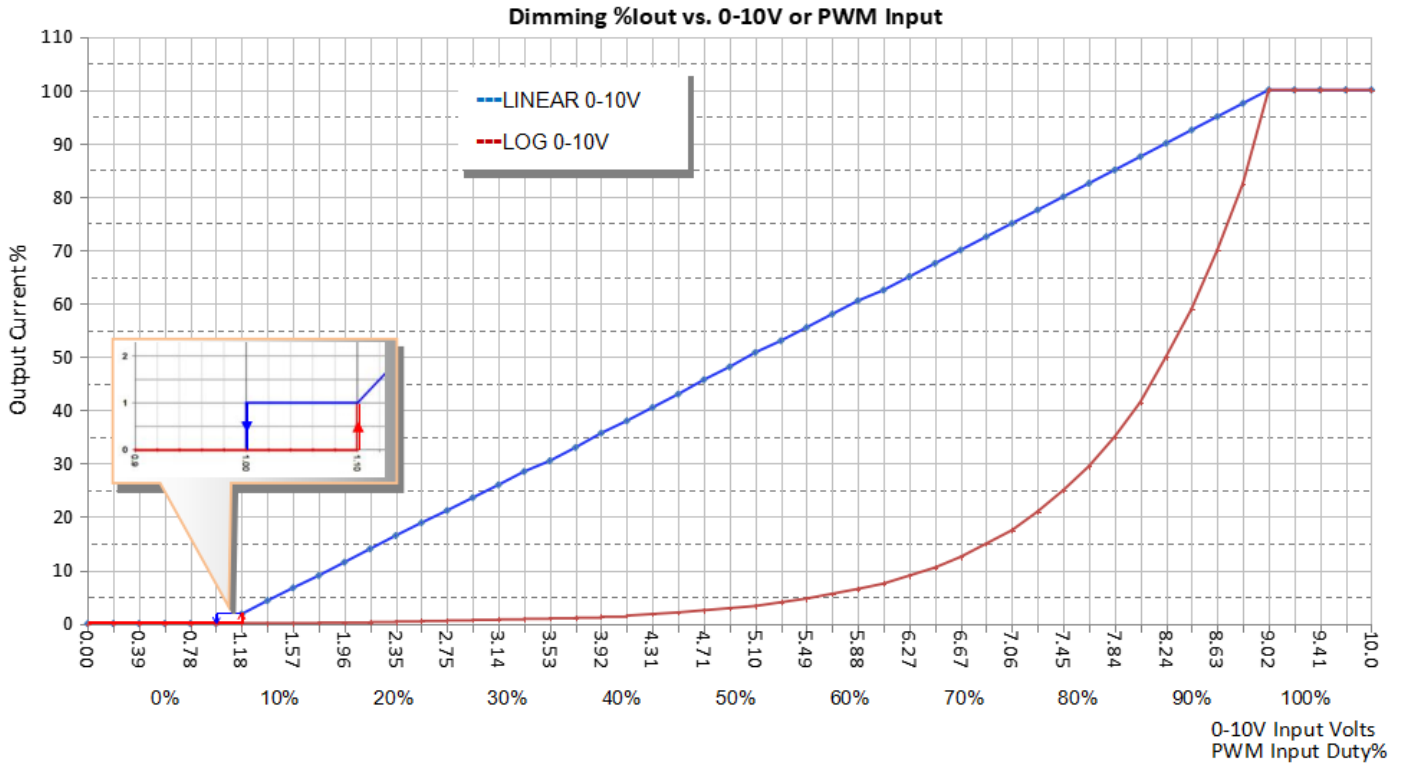

0-10V Dimming Curve @ Minimum dimming set to 10% and dim to off :

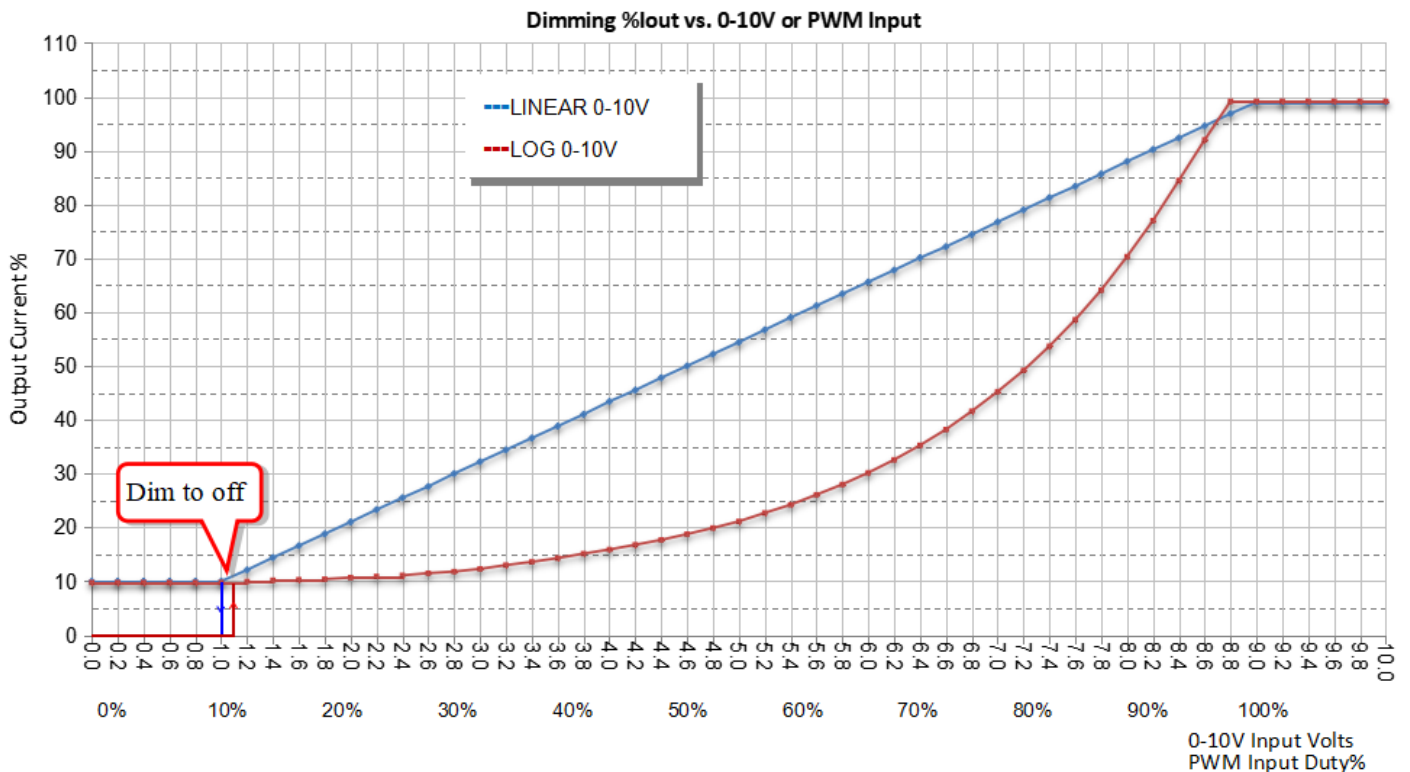

NTC Current Control

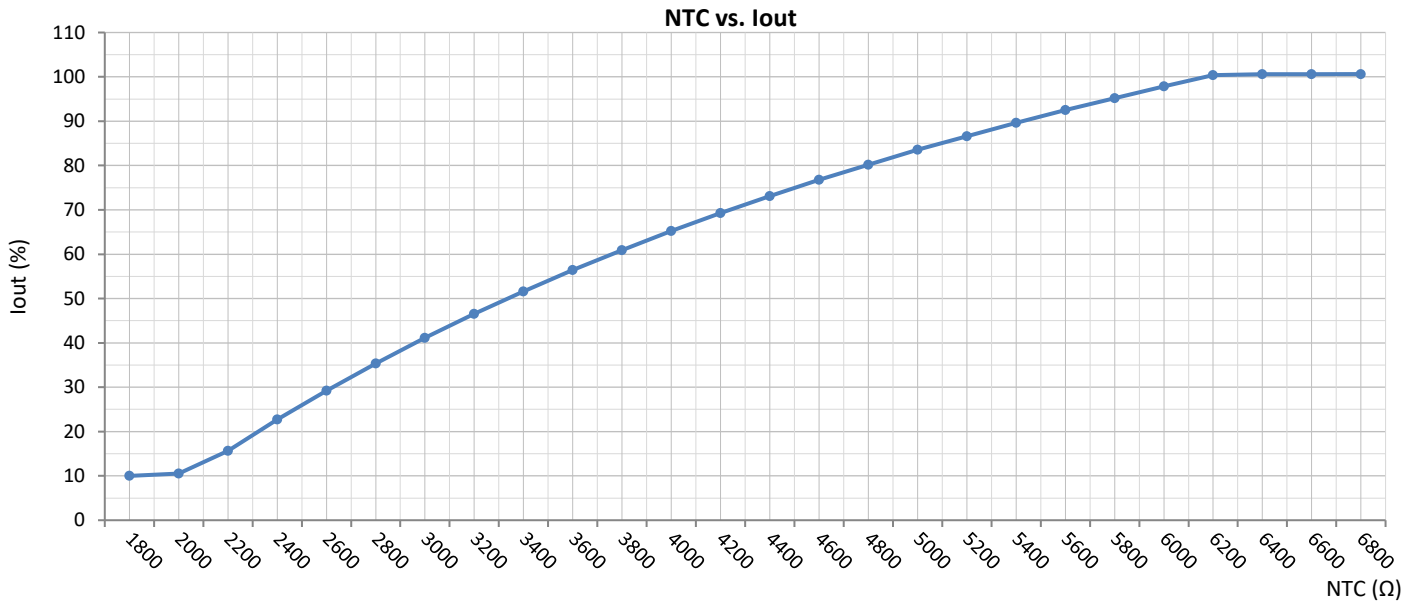

Note: Maximum dimming current is limited by NTC.

NTC values, NTC High, NTC Low and NTC Minimum Iout can be programmed.

Using Programmer USB interface & PC based GUI Software.

Default: NTC Low = 2.0K ~ 10% Iout, NTC High = 6.3K, 100% Iout.

Module Temperature Protection Example

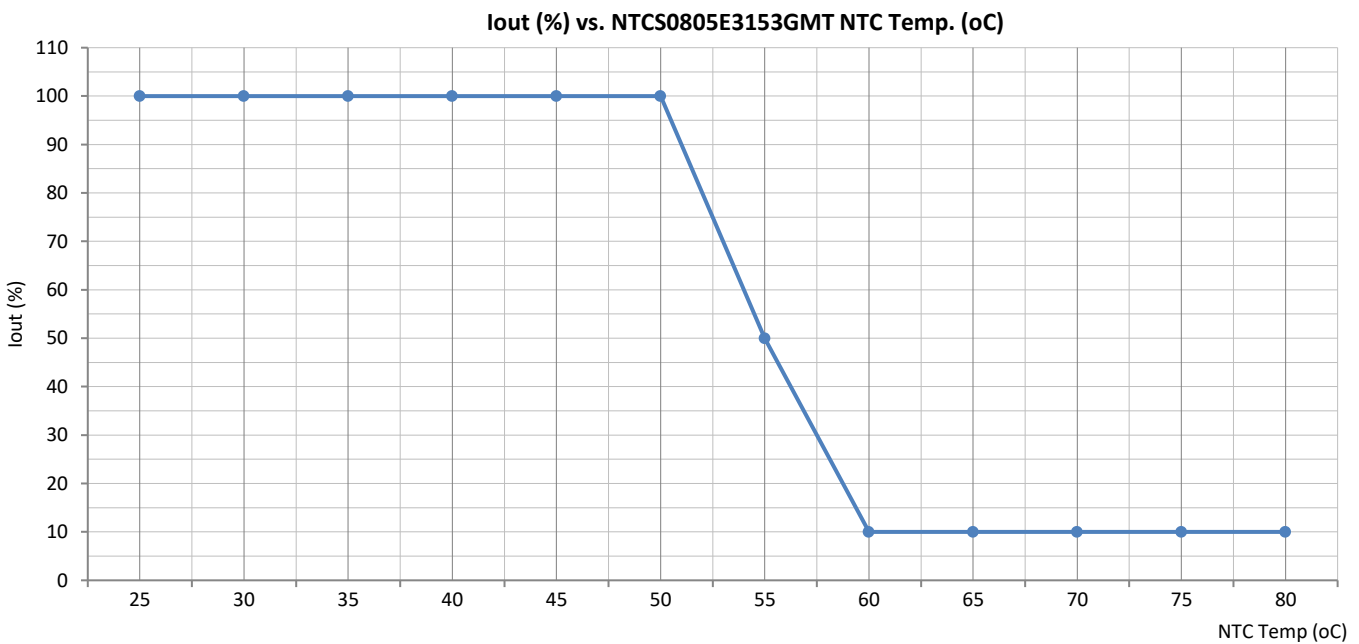

Power Operating Window & DLC Window:

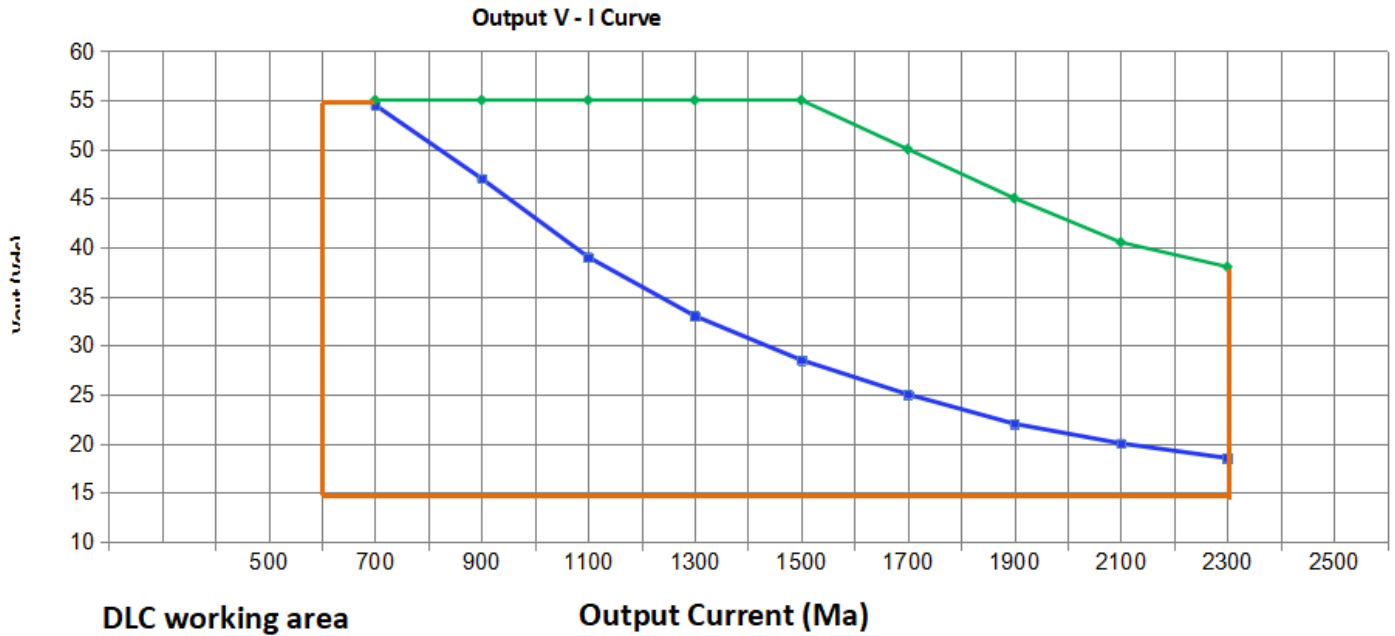

- PF>0.9 and THD<20%, Window that meet DLC standards at input 120-277V range.
- Power Operating Window.

Note: When the output current is set, the output voltage is automatically limited within the curves.

Output Current derating vs. TC Temperature Curve :

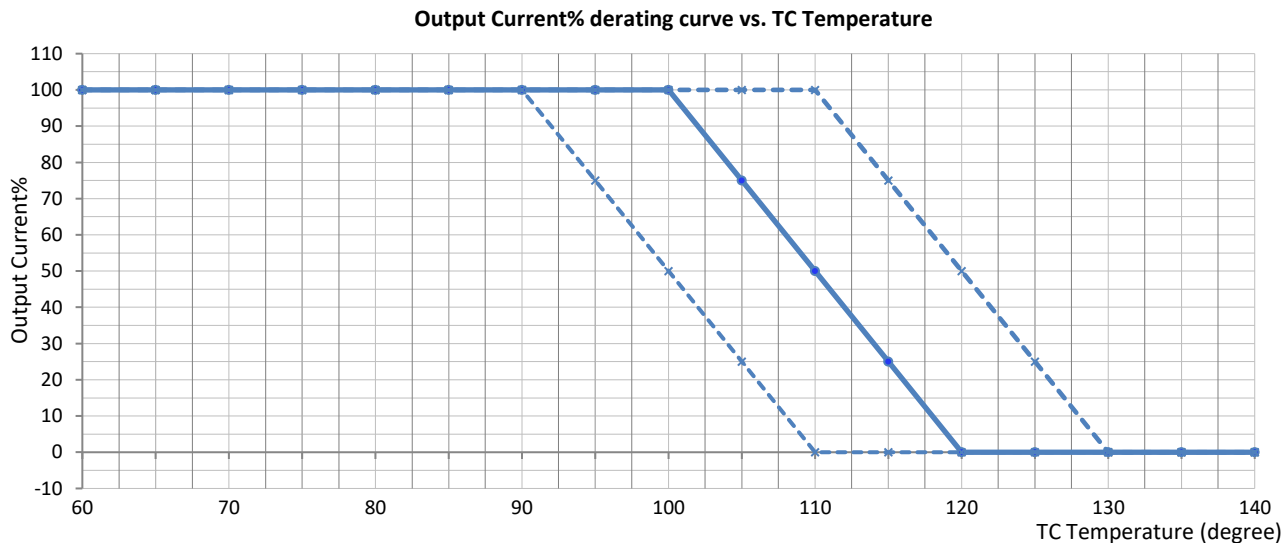

Note:

The temperature control curve is the test result of the technical sample, and the product is not tested.

Affected by the internal temperature distribution of the shell, the test temperature has a large error corresponding to the TC temperature.

■ Lifetime vs. Case Temperature

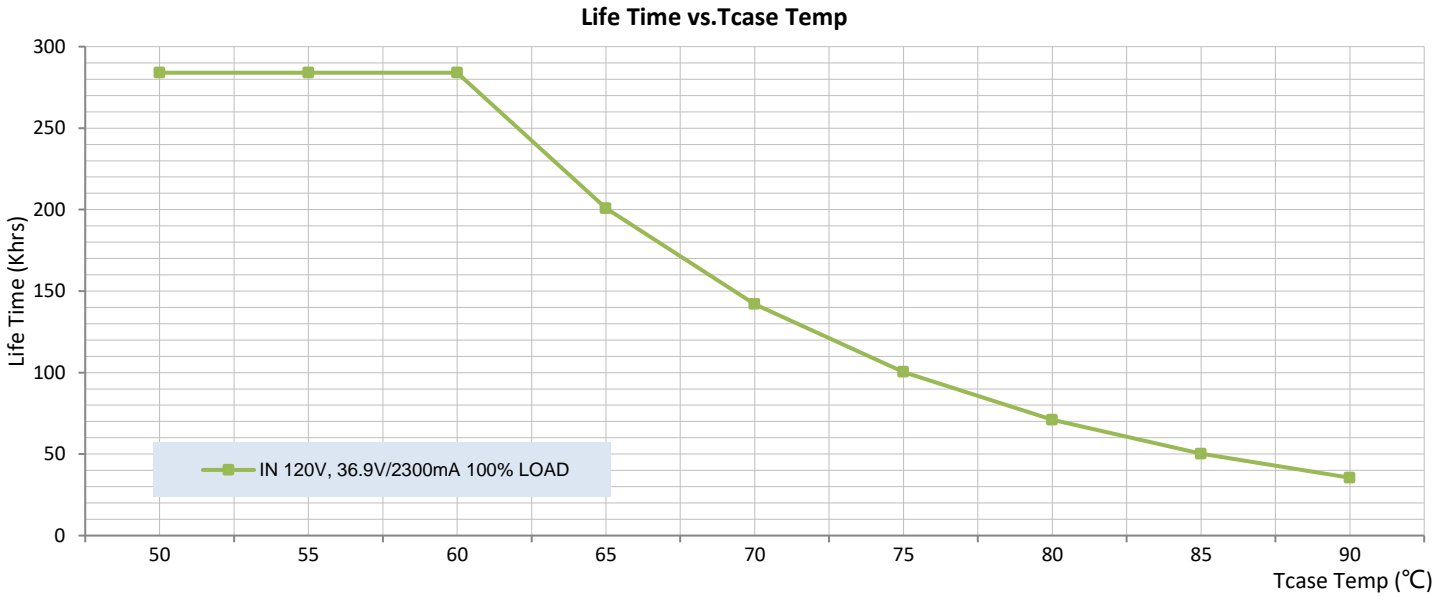

■ Efficiency vs. Load

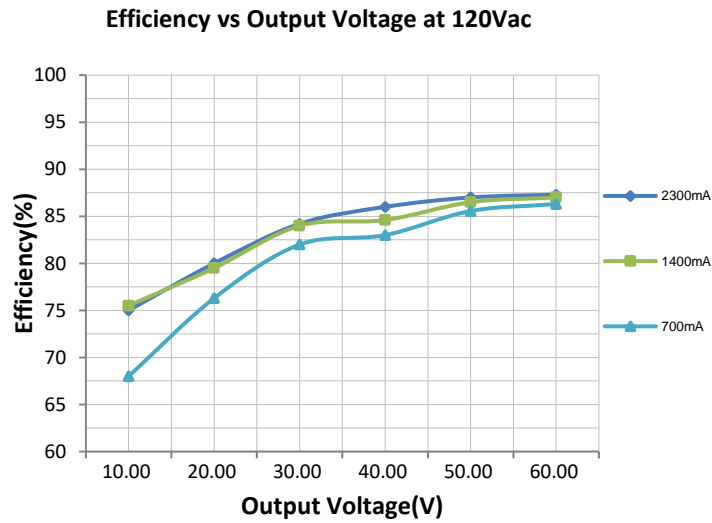

Efficiency vs Output Voltage at 277Vac

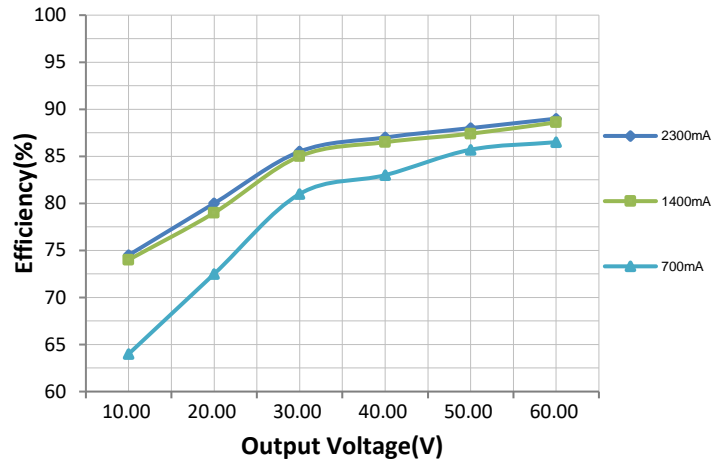

■ Power Factor vs. Load

Power Factor vs Output Power

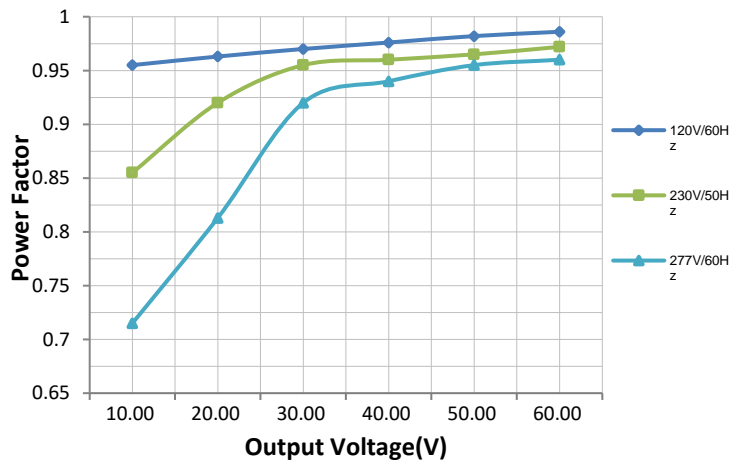

■ Programming:

Programmable Output Current (POC): Programmable I_{out} from 700mA to 2400mA.

Programmable Minimum Dim Level: 1% (OFF) to 100% I_{out} programmed value.

Programming Tool:

The programmer is a programming and configuration tool for intelligent programmable LED drivers. It consists of the programmer which is connected between the USB port of a computer and the LED driver being programmed, and the programmer software. The programmer software is a PC based graphical user interface that allows the user to program and configure the operating parameters of a programmable LED Driver. This interface allows the operator to set the LED drivers output current within its specified range. In the increments specified. It also provides the ability to enable/disable and control features like “Dimming”, “Constant Lumen Module” & “End-of-life indicator” when available in the intelligent LED driver being programmed.

Programmer:

Is the physical USB unit connected between the USB port of a computer and the LED driver being programmed? This unit also provides all power required to the LED driver being programmed. No connection to an AC power source is required for programming the LED driver.

Programmer Software:

The programmer software is the windows based GUI that allows the user to assign custom part number(s) to the LED driver being programmed. The user can then save the profile to a computer disk and recall as need. The user can then use the “Auto Program” feature to quickly program as many LED drivers with the saved profile as is required. Each driver programming simply requires a click of the mouse to program in a single step.

The programmer software supports bar code scanners. The barcode scanner can be used to automate the programming of the attached LED driver. The barcodes scanner interface also provides an option to either enable or disable logging of the parameters to an excel file.

Note: The programming of the LED driver does not require the input be connected to an AC power connection. The programmer and the required LED driver circuitry will be powered from the programmer module via the USB connection to a computer.

■ Mechanical Outline (Unit: mm)

Note: Metal shell; This product has two $\Phi 8.0$ mm mounting holes.

AC input for connection the three KF250-3.5 connectors; DC output for connection the four KFR250-3.5 connectors.

DALI dimming input for the two KFR250-3.5 connectors.

LED wiring distance

Recommended maximum wiring distance at full load.

AWG	#20	#19	#18	#17	#16
Distance (m)	14	18	22	28	36
Distance (ft)	45.9	59	72.2	91.9	118.1

KF250-3.5 CONNECTORS

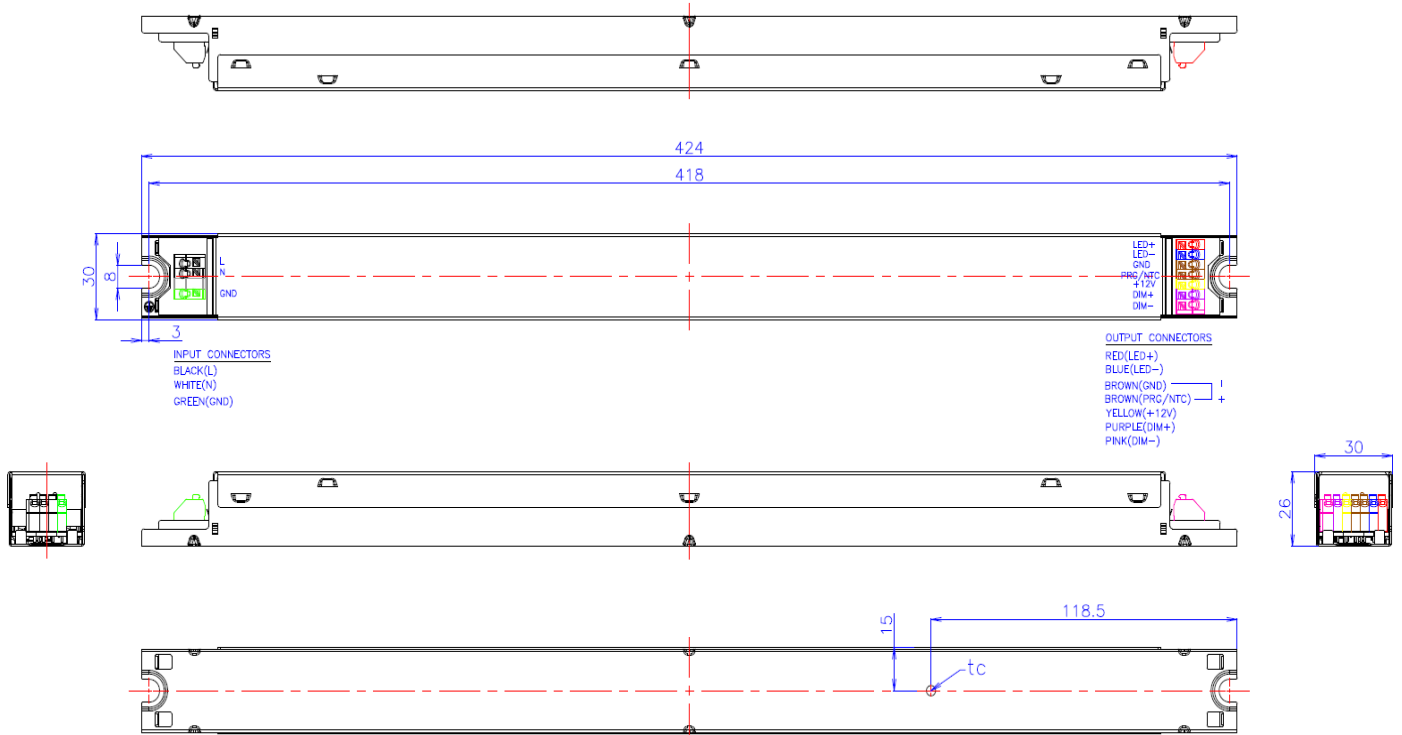
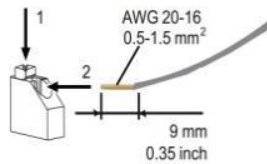

Figure 29, MR10YG

Note:

1. The DIM+ line can't touch the LED+ line and AC line.
2. LED- cannot be shorted with the SCOM and DIM-.

The independent LED drive conforms to the EMC standard. But it is not guaranteed to be qualified, when the drive is mounted in the LED fixture.

Please forgive us for any discrepancy due to the update of the specifications or the upgrade of the product. If you need the latest information, please contact our marketing department.

Revision

Date	Rev.	Description of Change		
		Item		
12/21/2023	V2a	Case mechanical drawing changed		