

## Main Features:

- Input Voltage: 180~528Vac or 250~740Vdc
- Output Wattage: Constant Wattage (C.P.) at 200W with Adjustable Current Setting
- Programmable Method: Wireless (NFC)
- High Efficiency: Up to **90%**
- Dimming Function: **0-10V with Dim to off (dto)**
- Auxiliary Voltage: **12Vaux with 300mA**
- Lightning Protection: Built-in Surge Protector at 10KV/5KA
- Reliability Protection: OVP, SCP, OTP
- Safety Regulation: Complies with UL8750 & EN61347
- **Type TL and HL** Program Certified from UL
- **Class P** UL standard for retrofit kit
- Waterproof Rating: IP67
- Five Year Warranty under Normal Usage Conditions



## SPECIFICATION

Model No. <sup>(i)</sup>	Output Voltage	Programmable Output	OVP	OTP	Case Temperature
	Range	Constant Current Range			
	(Vdc)	(mA) <sup>(i)</sup>	(Vdc max.)	(°C) <sup>(ii)</sup>	(Tc)
<b>LDD-200D190F1050HH-V</b>	114 - 286	700 - 1050	120% $V_{Omax}$ , typ.	$T_c \geq 105 \pm 10^\circ C$	90C
<b>LDD-200D143F1400HH-V</b>	86 - 190	1050 - 1400	120% $V_{Omax}$ , typ.	$T_c \geq 105 \pm 10^\circ C$	90C
<b>LDD-200D095F2100HH-V</b>	57 - 143	1400 - 2100	120% $V_{Omax}$ , typ.	$T_c \geq 105 \pm 10^\circ C$	90C
<b>LDD-200D048F4200HH-V</b>	29 - 71	2800 - 4200	120% $V_{Omax}$ , typ..	$T_c \geq 105 \pm 10^\circ C$	90C
<b>LDD-200D032F6300HH-V</b>	19 - 45	4400 - 6300	120% $V_{Omax}$ , typ..	$T_c \geq 105 \pm 10^\circ C$	90C
Note	(i) Pre-set Constant Current Value with dimming				
	(ii) Lower the output current when $T_c \geq 105 \pm 10^\circ C$ ; Auto Recovery When $T_c \leq 70 \pm 10^\circ C$   (iii) it is 240W model				

Input Spec.	Condition Description	Min.	Normal	Max.	Units
Input Voltage Range	Dedicated High Voltage Input	180	208-480	528	VAC
Input Frequency Range		47	50/60	63	Hz
Input Current	<b>277 VAC/480 VAC input, full load output</b>			<b>0.9/0.45</b>	A
Power Factor	@60% - 100% load		> 0.9		
THD (total harmonic distortion)	@60% - 100% load		< 15		%
Inrush Current	At 277 VAC input, 25°C cold start / At 480 VAC input, 25°C cold start			82.8 / 120.4	A
Leakage Current	max @277Vac 60Hz			1.0	mA
Surge Protection	Common mode (L-G and N-G) in 10kv, Differential mode (L-N) in 6kv, IEC 61000-4-5				

Output Spec.	Condition Description	Min.	Normal	Max.	Units
Current Accuracy			±5		%
Ripple Current	At 100%-60% Load. The result differs according to different LED load characteristic.			5	% Ip-p (Io)
Overshoot/Undershoot	% of Iout max & LED load			10	%
Turn-On Delay	Startup time at cold start			1.2	s
Auxiliary Power (Vaux)	With 300mA max	-5%	12	+5%	Vdc

General Spec.	Condition Description	Min.	Normal	Max.	Units
Efficiency	Measured at full load in the thermal balanced condition		91		%
MTBF	measured at Tc= 75°C (MIL-HDBK-217F)		≥280,000		Hours
Lifetime	measured at Tc= 75°C		≥100,000		Hours
Operating/Storage Temperature	10%RH~100%RH	-40/-40		90/85	°C
Dimension (OL/L x W x H)	OL is the overall length with mounting plates	251/225*68*33.5			mm
		9.88/8.85*2.68x1.31			inch
Weight	Net weight without package	2.43/1.1			lb/kg

Safety & EMC Compliance	Category	Condition Description
Safety Regulations	UL8750	Light Emitting Diode(LED) Equipment for Use in Lighting Products
	UL1012	Power Unit Other Than Class 2
	IEC 61347-1	Lamp Controlgear Part 1: General and Safety Requirements
	IEC 61347-2-13	Lamp Controlgear Part 2-13: Particular Requirement for d.c. or a.c. Supplied Electronic Controlgear for LED Modules
	CE	Europe: EN 61347-1, EN61347-2-13
EMI Standards	IEC 55015	Conducted emission test & Radiated emission test
	IEC 61000-3-2	Harmonic current emissions; Class C (≥75% load)
	IEC 61000-3-3	Voltage fluctuations & flicker
	FCC Part 15	Class B
EMS Standards	IEC 61000-4-2	Electrostatic discharge (ESD)
	IEC 61000-4-3	Radio frequency electromagnetic field susceptibility test (RS)
	IEC 61000-4-4	Electrical fast transient (EFT)
	IEC 61000-4-5	Surge immunity test L-N:2kV; LN-PE:4kV ( <a href="#">Surge Protection Device 4KA/6KV or 6KA/10KV</a> )
	IEC 61000-4-6	Conducted radio frequency disturbances test (CS)
	IEC 61000-4-8	Power frequency magnetic field test
	IEC 61000-4-11	Voltage dips
	IEC 61547	Electromagnetic immunity requirements applies to lighting equipment

## ■ Dimming Curve

Parameter	Min.	Typ.	Max.
Vdim Sourcing Current	100uA	150uA	200uA
Vdim Allowed Input Voltage	-20 V		20 V
0-10V Dimming Range	10% (Vdim=1V)	Linear	100% (Vdim=9~10V)
PWM Dimming Range	10% (Duty=10%)	Linear	100% (Duty=90-100%)
Dim off threshold	0.4V or 4%	0.5V or 5%	0.6V or 6%
Dim on threshold	0.6V or 6%	0.7V or 7%	0.8V or 8%
PWM High	3.8V		10V
PWM Low	0V		0.6V
PWM Frequency	300Hz		2kHz
External PWM Controller Current Sinking Capability	300uA		

With dim-off (dto)

0-10V Dimming Curve

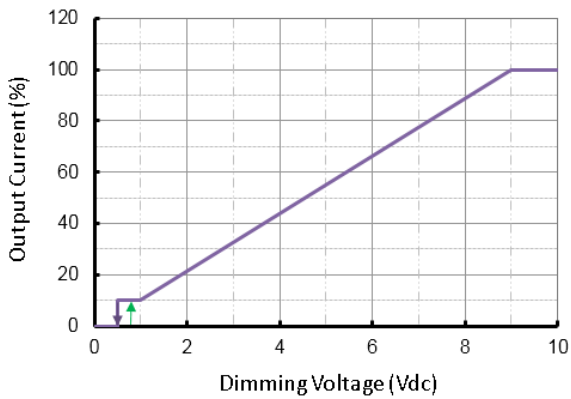

PWM Dimming Curve

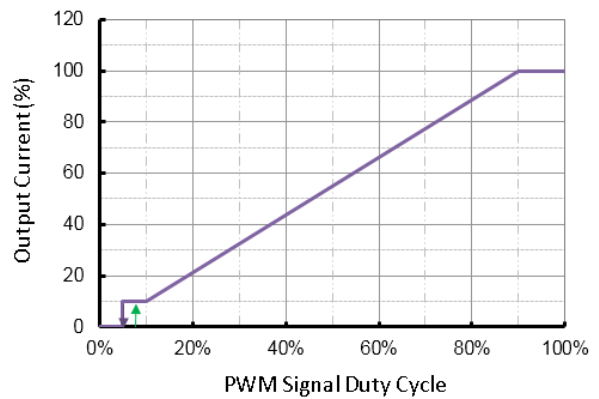

Dimming Wire

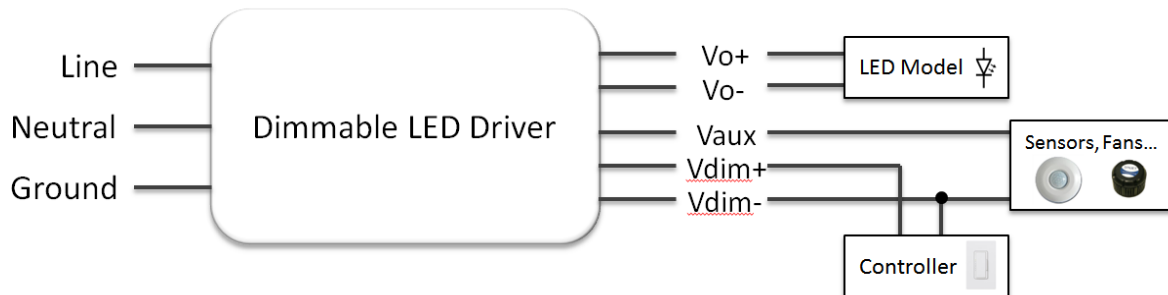

■ Lifetime vs. Case Temperature

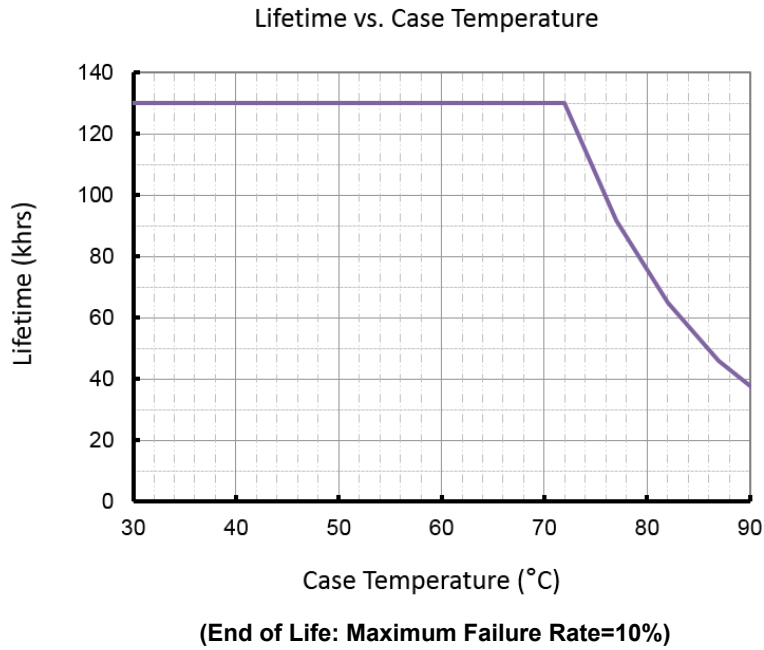

■ Power Factor VS Load

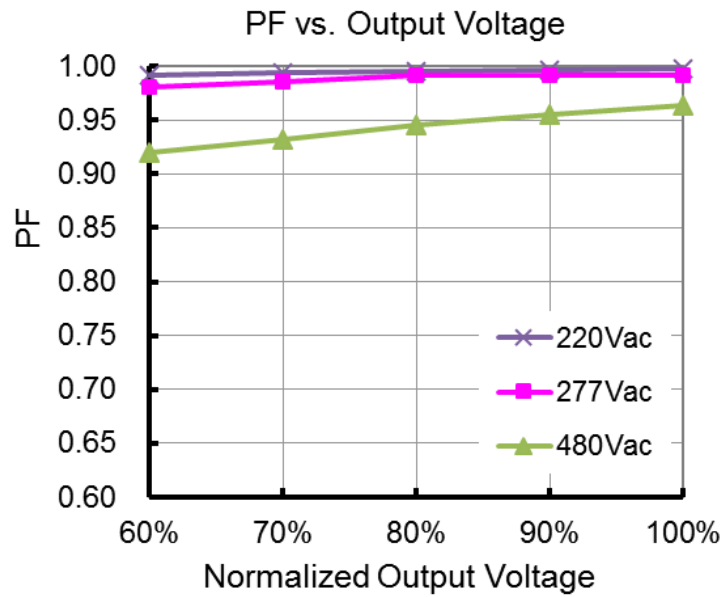

■ THD VS Load

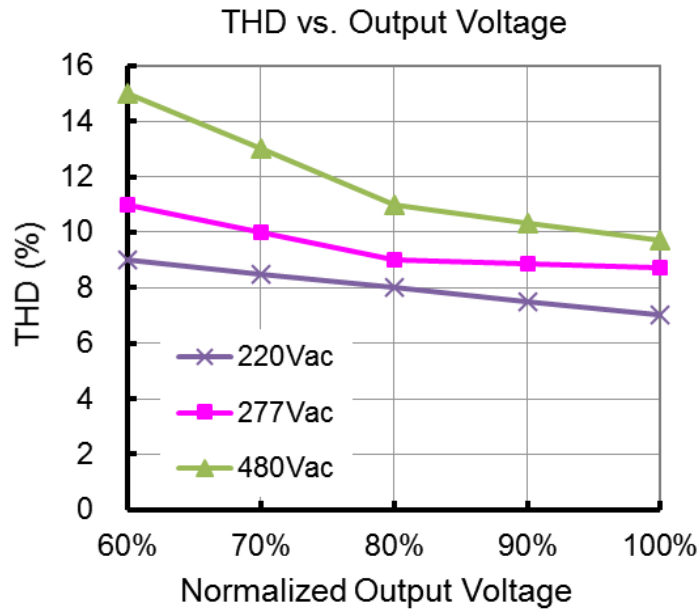

■ Efficient VS Load(2.1A model)

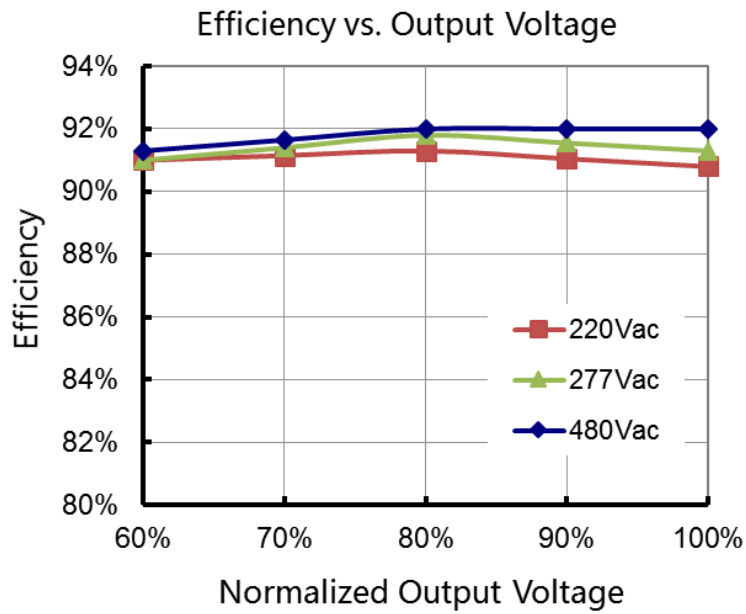

■ Inrush current

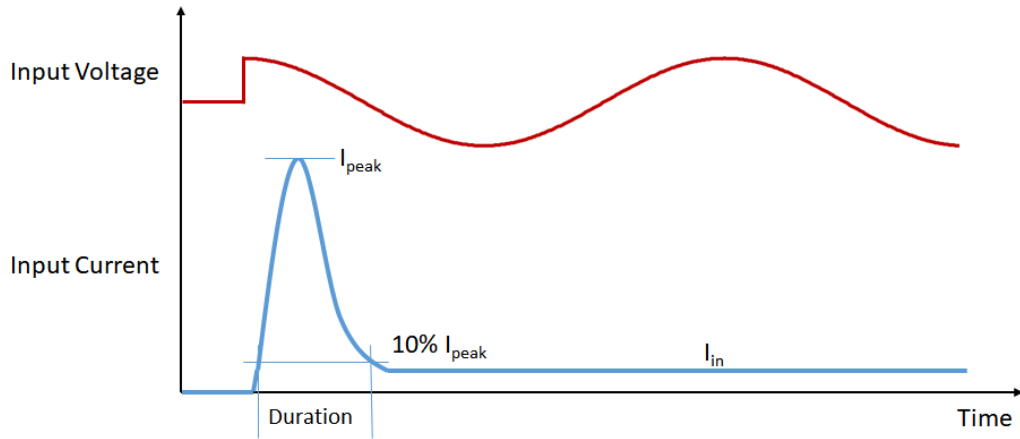

Input Voltage	$I_{peak}$	Duration
277Vac	82.8A	492us
380Vac	100.4A	376us
480Vac	120.4A	356us

■ Dielectric Strength

Unit: Vac	Input	Output	Dimming	Case
Input	-	3920	3920	1960
Output	3920	-	1960	1960
Dimming	3920	1960	-	1960
Case	1960	1960	1960	-

■ Tc Point

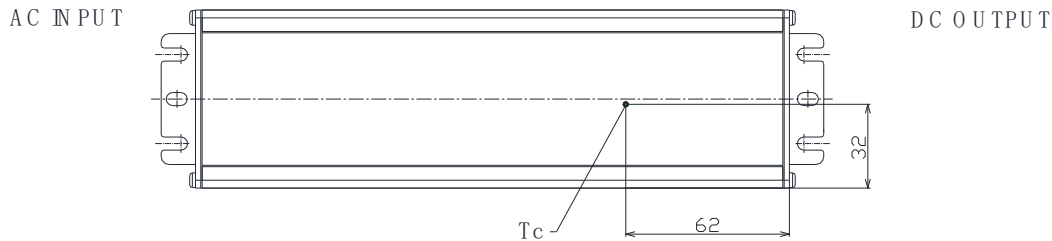

■ **Packaging information**

Typical Carton Dimension(L×W×H)	490×370×115 mm
Positioning plate	2pcs/carton
Shield Board	1pcs/carton
LED Drivers	10pcs/carton

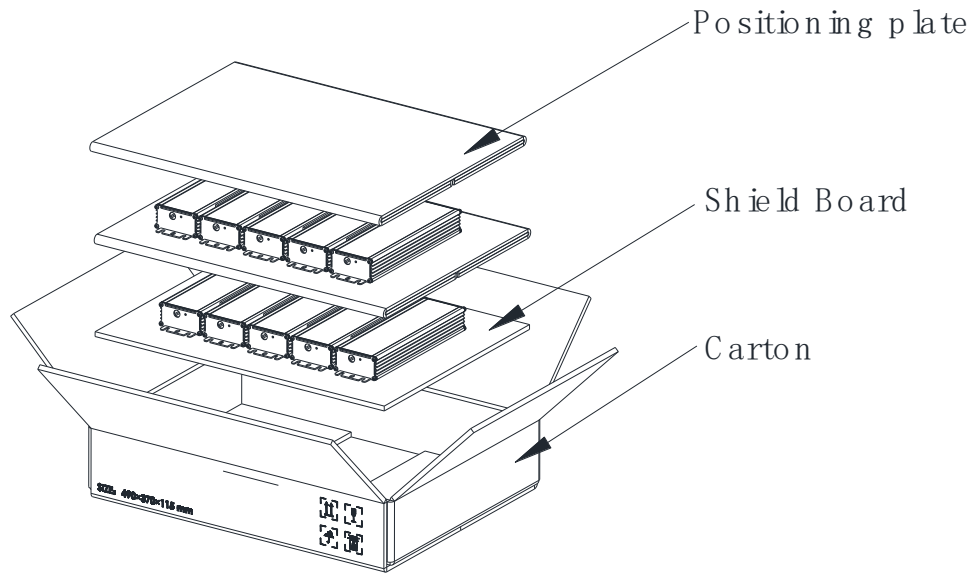

■ Current vs. Voltage Curve

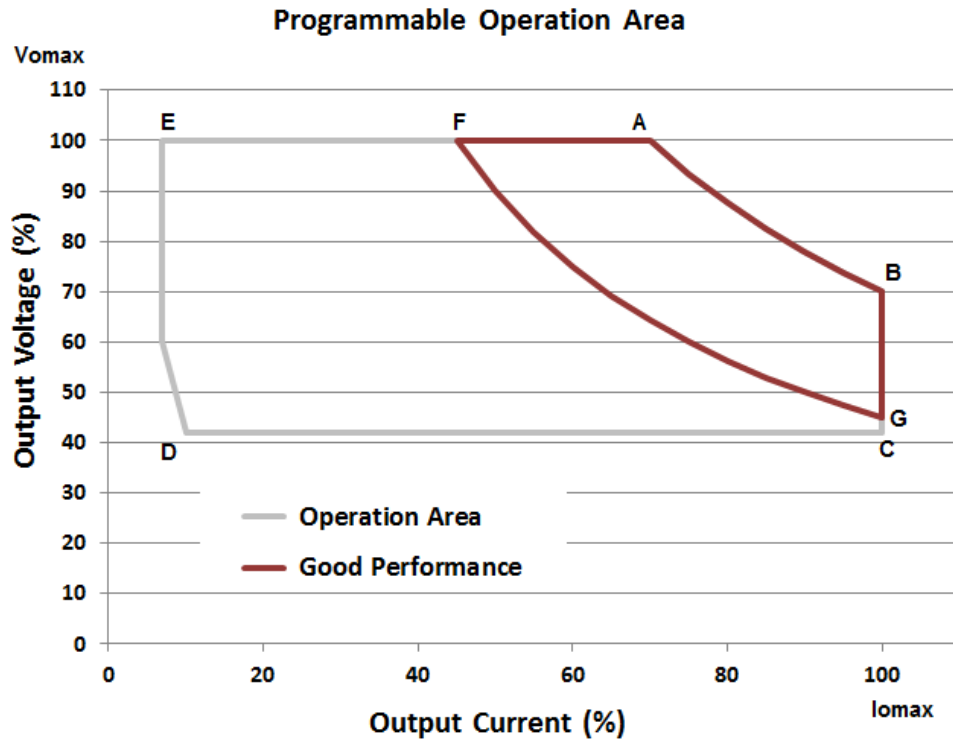

$I_o$ (mA)   $V_o$ (V)	<b>B</b> $I_{max}$ (Rated)	<b>A</b> $V_{max}$ (min $I$ of C.P.)	<b>F</b> (60% of $I$ at A)   (as $V_{max}$ )	<b>G</b> (as $I_{max}$ )   (60% of $V$ at B)	<b>C</b> (as $I_{max}$ )   $V_{min}$ = (60% of $V$ at B)	<b>D</b> (10% of $I_{max}$ )   (60% of $V$ at B)	<b>E</b> (10% of $I$ at A)   (as $V_{max}$ )
LDD-200D190F1050HH-V	1050   190	700   286	420   286	1050   114	1050   114	105   114	70   286
LDD-200D143F1400HH-V	1400   143	1050   190	630   190	1400   86	1400   86	140   86	105   190
LDD-200D095F2100HH-V	2100   95	1400   143	840   143	2100   57	2100   57	210   57	140   143
LDD-200D048F4200HH-V	4200   48	2800   71	1680   71	4200   29	4200   29	420   29	280   71
LDD-200D032F6300HH-V	6300   32	4400   45	2640   45	6300   19	6300   19	630   19	440   45
On BA Curve Line	Constant Power Area						
Within BAFG Box	Good Performance Area						
Within ABCDE Box	Operational Area						



## ■ Mechanical Outline (Unit: mm)

Note: Dimensions in millimeters, where 25.4 mm = 1 inch

Tolerance:  $\pm 0.51$  mm

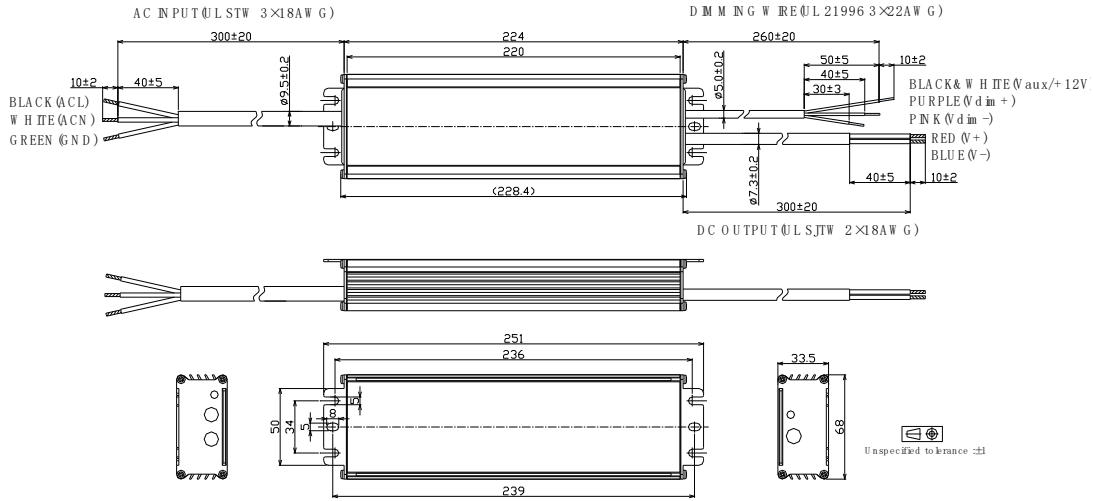

**Safety Note:** Please make sure the output cable does not connect to dimming cable or the cables of other drivers until 20 seconds after being tested because of the remained voltage in the output capacitor.

**Revision**

Date	Rev.	Description of Change		
		Item	Old	New
11/20/2022	V2a	In Draft Release	/	/