

Main Features:

- Input Voltage: 90~305Vac or 127~420Vdc
- Output Wattage: Constant Wattage (C.P.) at **120W**
with Adjustable Current Setting
- Programmable Method: Wireless (**NFC**)
- High Efficiency: Up to **90%**
- Dimming Function: DALI2.0/D4I
- Integrated 16Vdc Bus Power supply
- Auxiliary Voltage: 24Vaux with **3W**
- Lightning Protection: Built-in Surge Protector at 10KV/5KA
- Reliability Protection: OVP, SCP, OTP
- Safety Regulation: Complies with UL8750 & EN61347
- **Type TL and HL** Program Certified from UL
- **Class P** UL standard for retrofit kit
- Waterproof Rating: IP67
- **Seven Year Warranty** under Normal Usage Conditions (@ Tc<=75°C)



SPECIFICATION

Model No. ⁽ⁱ⁾	Output Voltage Range	Programmable Output Constant Current Range	OVP	OTP	Case Temperature
	(Vdc)	(mA) ⁽ⁱ⁾	(Vdc max.)	(°C) ⁽ⁱⁱ⁾	(Tc)
LDD-120D114F1050-U-D4	69-171	700 - 1050	120% Vomax, typ.	Tc≥105±10°C	90C
LDD-120D086F1400-U-D4	51-114	1050 - 1400	120% Vomax, typ.	Tc≥105±10°C	90C
LDD-120D043F2800-U-D4	26-57	2100 - 2800	120% Vomax, typ.	Tc≥105±10°C	90C
LDD-120D032F3800-U-D4	19-43	2800 - 3800	120% Vomax, typ.	Tc≥105±10°C	90C
Note	⁽ⁱ⁾ Pre-set Constant Current Value with dimming ⁽ⁱⁱ⁾ Lower the output current when Tc≥105±10°C; Auto Recovery When Tc≤70±10°C				

Input Spec.	Condition Description	Min.	Normal	Max.	Units
Input Voltage Range	Universal Input	90	100-277	305	VAC
Input Frequency Range		47	50/60	63	Hz
Input Current	220 VAC input, full load output			0.6	A
Power Factor	At 100 VAC/220 VAC input		>0.9		
Inrush Current	At 230 VAC input, 25°C cold start / At 277 VAC input, 25°C cold start			66.8 / 90	A
Leakage Current	max @277Vac 60Hz			0.001	A
Surge Protection	Line to line 4kV, line to ground 10kV, IEC 61000-4-5				

Output Spec.	Condition Description	Min.	Normal	Max.	Units
Current Accuracy			±5		%
Ripple Current	At 100%-60% Load. The result differs according to different LED load characteristic.			5	% Ip-p (Io)
Overshoot/Undershoot	% of Iout max & LED load			10	%
Turn-On Delay	Measured at 110 VAC/220 VAC input and Full Load			1.2	S
Auxiliary Power (Vaux)	With 300mA max	21.5	24	26.5	Vdc

General Spec.	Condition Description	Min.	Normal	Max.	Units
Efficiency	Measured at full load and 220Vac in the thermal balanced condition.		92	93	%
MTBF	measured at Tc= 75°C (MIL-HDBK-217F)		≥320,000		Hours
Lifetime	measured at Tc= 75°C		≥100,000		Hours
Operating/Storage Temperature	10%RH~100%RH (See De-rating Curve for more details)	-40/-40		90/85	°C
Dimension (OL/L x W x H)	OL is the overall length with mounting plates	158/132 x 68 x 38.5			mm
		6.22/5.2 x 2.66 x 1.52			inch
Weight	Net weight without package	1.76/0.80			lb/kg

Safety & EMC Compliance	Category	Condition Description
Safety Regulations	UL8750	Light Emitting Diode(LED) Equipment for Use in Lighting Products
	UL1012	Power Unit Other Than Class 2
	IEC 61347-1	Lamp Controlgear Part 1: General and Safety Requirements
	IEC 61347-2-13	Lamp Controlgear Part 2-13: Particular Requirement for d.c. or a.c. Supplied Electronic Controlgear for LED Modules
	CE	Europe: EN 61347-1, EN61347-2-13
EMI Standards	IEC 55015	Conducted emission test & Radiated emission test
	IEC 61000-3-2	Harmonic current emissions; Class C (≥75% load)
	IEC 61000-3-3	Voltage fluctuations & flicker
	FCC Part 15	Class B
EMS Standards	IEC 61000-4-2	Electrostatic discharge (ESD)
	IEC 61000-4-3	Radio frequency electromagnetic field susceptibility test (RS)
	IEC 61000-4-4	Electrical fast transient (EFT)
	IEC 61000-4-5	Surge immunity test
	IEC 61000-4-6	Conducted radio frequency disturbances test (CS)
	IEC 61000-4-8	Power frequency magnetic field test
	IEC 61000-4-11	Voltage dips
	IEC 61547	Electromagnetic immunity requirements applies to lighting equipment

■ Dimming Curve

Parameter	Min.	Typ.	Max.
DALI Interface Standard	IEC62386-101,102,150,207,250,251,252,253		
Dimming Range	10%	-	100%
DA1,DA2 High Level	9.5V	16V	22.5V
DA1,DA2 Low Level	-6.5V	0	6.5V
DA1,DA2 Current	0		2mA
Bus Power Supply Voltage	12Vdc	16Vdc	20Vdc
Bus Power Supply Current	52mA	-	60mA
Auxiliary Power Voltage	21.6V	24V	26.4V
Auxiliary Power	3W	-	4W
Auxiliary Power Endurance @6W	3.8ms/6ms	-	4.5ms/6ms
Auxiliary Power Endurance @10W	1.8ms/6ms	-	2.2ms/6ms
Bus Power Supply Current	52mA	-	60mA

Dimming Wire

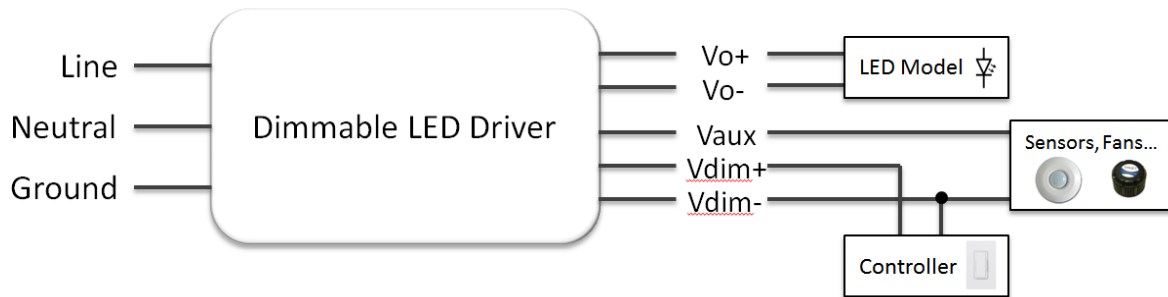

■ Lifetime vs. Case Temperature

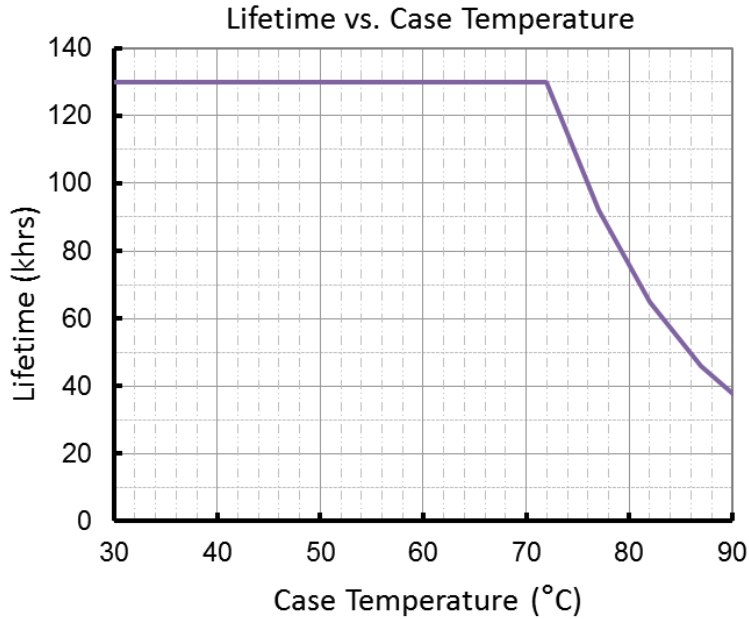

(End of Life: Maximum Failure Rate=10%)

■ Power Factor VS Load

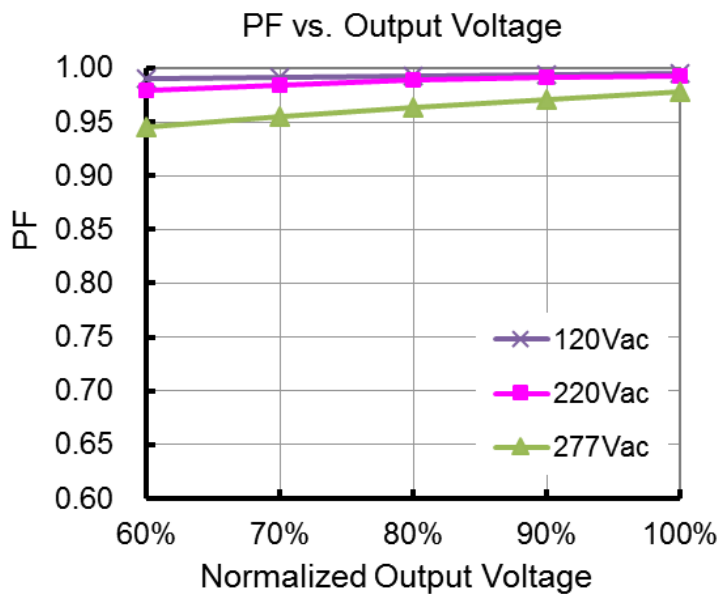

■ THD VS Load

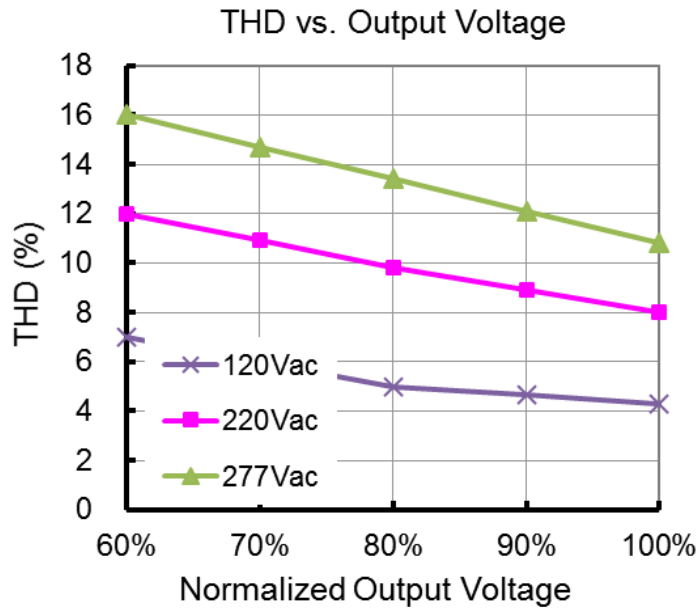

■ Efficient VS Load(1.05A model)

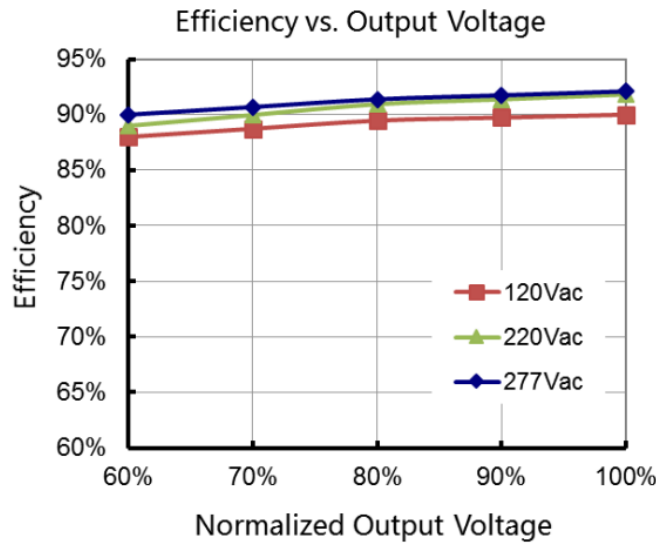

■ Inrush current

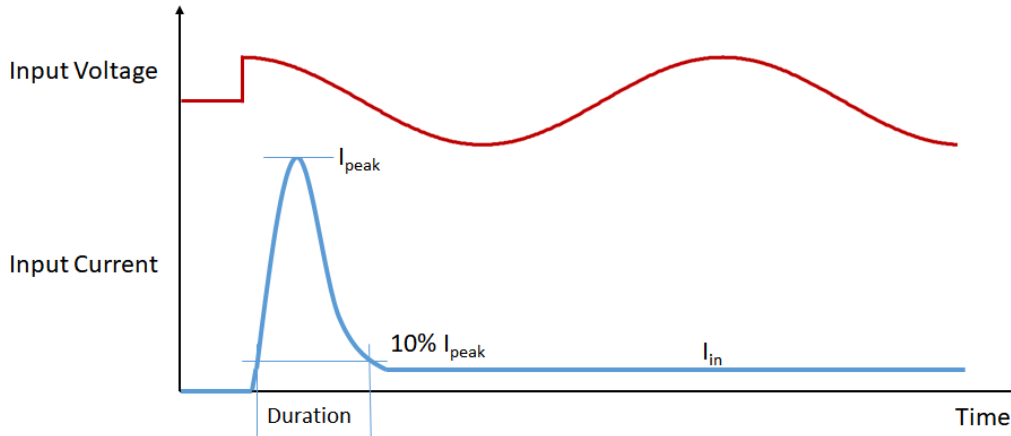

Input Voltage	I_{peak}	Duration
220Vac	66.8A	824us
277Vac	90A	760us

■ Dielectric Strength

Unit: Vac	Input	Output	Dimming	Case
Input	-	3750	3750	1554
Output	3750	-	1554	1554
Dimming	3750	1554	-	1554
Case	1554	1554	1554	-

■ Tc Point

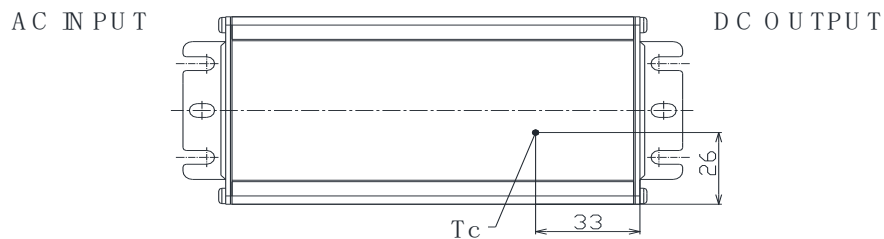

■ **Packaging information**

Typical Carton Dimension(L×W×H)	490×280×165 mm
Positioning plate	3pcs/carton
Shield Board	1pcs/carton
LED Drivers	15pcs/carton

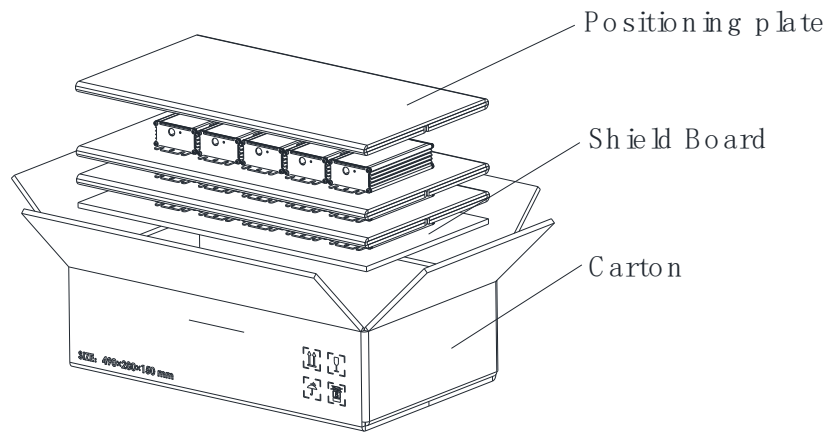

■ Current vs. Voltage Curve

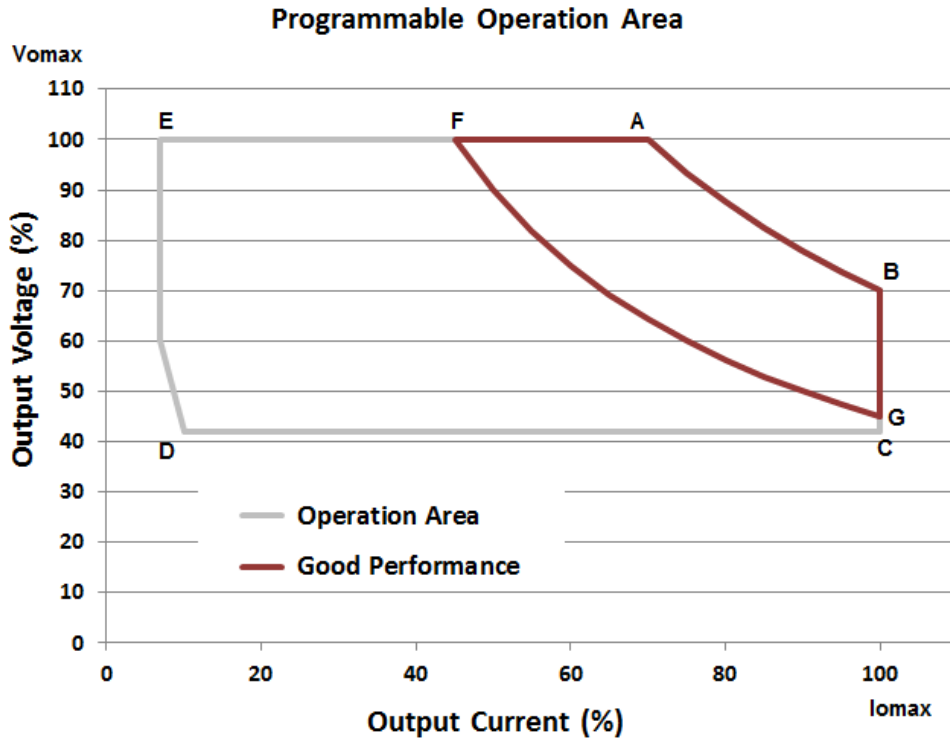

I_o (mA) V_o (V)	B I_{max}	A V_{max}	F (60% of I at A) (as V_{max})	G (as I_{max}) (60% of V at B)	C (as I_{max}) $V_{min} =$ (60% of V at B)	D (10% of I_{max}) (60% of V at B)	E (10% of I at A) (as V_{max})
LDD-120D114F1050-U-D4	1050 114	700 171	420 171	1050 68	1050 68	105 68	70 171
LDD-120D086F1400-U-D4	1400 86	1050 114	630 114	1400 52	1400 52	140 52	105 114
LDD-120D043F2800-U-D4	2800 43	2100 57	1260 57	2800 25	2800 25	280 25	210 57
LDD-120D032F3800-U-D4	3800 32	2800 43	1680 43	3800 19	3800 19	380 19	280 43
On BA Curve Line	Constant Power Area						
Within BAFG Box	Good Performance Area						
Within ABCDE Box	Operational Area						

■ Mechanical Outline (Unit: mm)

Note: Dimensions in millimeters, where 25.4 mm = 1 inch

Tolerance: ± 0.51 mm

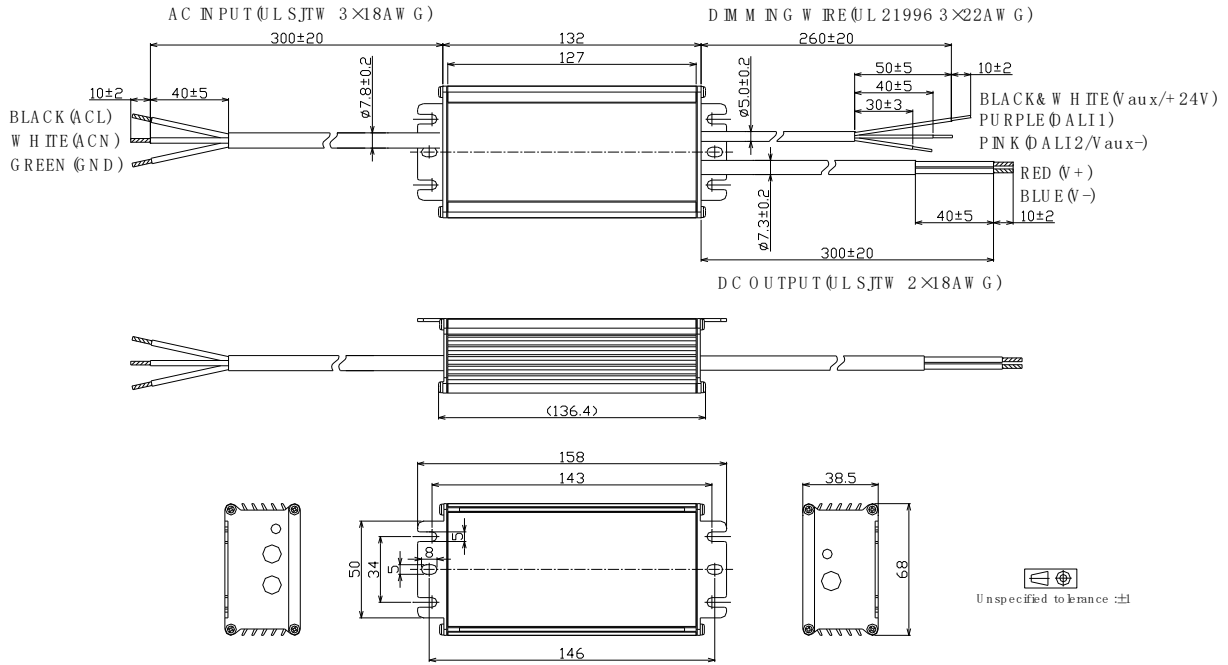

Safety Note: Please make sure the output cable does not connect to dimming cable or the cables of other drivers until 20 seconds after being tested because of the remained voltage in the output capacitor.

Revision

Date	Rev.	Description of Change		
		Item	Old	New
11/13/2022	V2a	In Draft Release	/	/